



**LASER CUTTING  
SOLUTIONS**

**2D / 3D / 3D 5-axis / Automation / Tube**



# Contents

01  HF/BF Series P3-6

02  HF PRO/SF Series P7-8

03  F/PRO/G Series P9-12

04  MPS-Precision Series P13

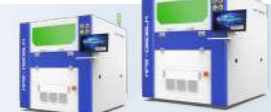
05  MPS C/D Series P14

06  Giant Series P15-16

07  RDC Series P17-18

P19

W Series



08

P20

SL Series

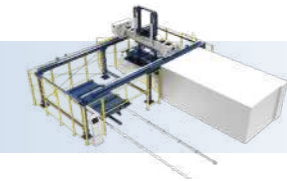

09

P21-22

SLU Series



10

P23-24

ALU Series



11

P25-26

SP/TP Series



12

P27-30

PD/PDi Series

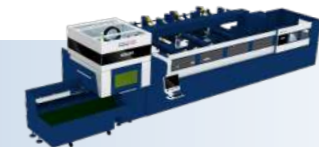

13

P31-32

TD Series



14

# Overview



HAN'S LASER GLOBAL MANUFACTURING BASE (1st)



Headquarters



HAN'S LASER GLOBAL MANUFACTURING BASE (2nd)



Changzhou Factory



Tianjing Factory



Hunan Factory



Dallas Factory, USA

## INTRODUCTION

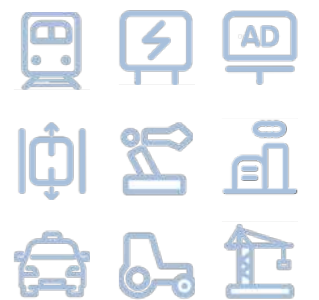

APPLICATIONS

Han's Laser Smart Equipment Group is a wholly-owned subsidiary of Han's Laser, focus on R&D, manufacturing, selling and providing service of medium and high power 2D & 3D laser cutting machine, laser tube cutting machine, large-format laser cutting machine, roll dynamic cutting machine, laser automation line, press brake and etc.

As one of the top company in China, Han's Laser Smart Equipment Group known as a national pilot of high-tech manufacturing base, National High-Tech Enterprise, and GB standard committee. The 5th fiber laser cutting machine rewarded as national quality standard product in 2017, international credit brand and etc. Han's fiber laser cutting machine was highly recommend by MIIT (ministry of industry and information technology). Han's laser machines are widely used in over 30 countries, the industry covering the rail transportation, energy and petrochemical, electric power, automobile manufacturing, construction machinery, agricultural machinery, construction machinery, elevator manufacturing, advertising decoration and etc.

Han's products verified by CE for all standard models, company has passed ISO9001, ISO14001 certification, each process of production are strictly under quality control. We guarantee product performance, services and delivery period.

Han's Laser Smart Equipment Group offers comprehensive machinery for fabricators in metal manufacturing, and provides fulfill laser machinery solutions. Our sales network expands to 30 counties in order to serve global clients with high quality laser machine and comprehensive services.

# HF Series

Fiber Laser Cutting Machine

## G10025HF



Images only for reference

### Features

- Reliable and strict mechanism design
- Global supplied high-end key functional components
- Han's innovated CNC system
- Processing database for high-power laser applications
- Machine with higher productivity, precision, efficiency, and larger format
- Comprehensive solutions for thin, middle and thick plate cutting



Model	G3015HF	G4020HF	G6020HF	G6025HF
Processing area	3000mm×1500mm	4000mm×2000mm	6000mm×2000mm	6000mm×2500mm
Repeatability(X/Y)	±0.02mm	±0.02mm	±0.02mm	±0.02mm
Positioning Speed (X/Y)	200m/min	200m/min	160m/min	160m/min
Acceleration (X/Y)	2.8G	2.8G	2.5G	2.5G
Max. load weight	900Kg	1600Kg	5600Kg	7000Kg
Dimensions (L*W*H)	961.5×304×216cm	1123×347×216cm	1570×356×240cm	1570cm×406cm×240cm

\*Laser power 6KW 8KW 12KW 15KW 20KW 30KW 40KW

1



#### Full-hollow Machine Bed

Rigid and anti-deformation machine bed for 30KW ultra-high power laser cutting

2



#### Brand new user interface

European design UI and UX, Intelligent operation, fluent system reaction

3



#### Z-axis gear and rack system

Patented design, anti-pollution, anti-crashing and fast speed

4



#### Dual-Motor Exchange Pallet

Facilitate machine maintenance, Prevent unexpected movement

5

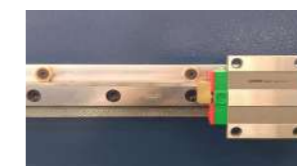

#### Double safety lock guide rail

Prevent accuracy error happen when laser head collides

6



#### Modular workbench for high power laser cutting

Easy to be dismantled and installed

7

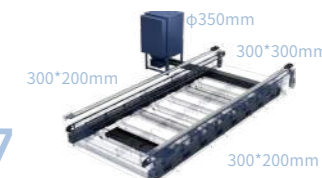

#### Efficient ventilation system

CAE ventilation pathway with large size ventilation channel

8



#### Anti-burning cover for high-power cutting

Easy maintenance and low cost

9



#### High strength tank chain mechanism

Large torque standard with larger bearing weight

G8025HF	G10025HF	G12025HF	G12030HF
8000mm×2500mm	10000mm×2500mm	12000mm×2500mm	12000mm×3000mm
±0.02mm	±0.05mm	±0.05mm	±0.05mm
160m/min	140m/min	140m/min	140m/min
2.5G	1.5G	1.5G	1.5G
9400Kg	12000Kg	14100Kg	16000Kg
1920cm×406cm×240cm	2410cm×423cm×261cm	2840cm×423cm×261cm	2840cm×480cm×261cm

\*Laser power 6KW 8KW 12KW 15KW 20KW 30KW 40KW

\*Only for reference, technical data are subject to technical proposals

# BF Series

Fiber Laser Cutting Machine (Bevel)

## G12030BF

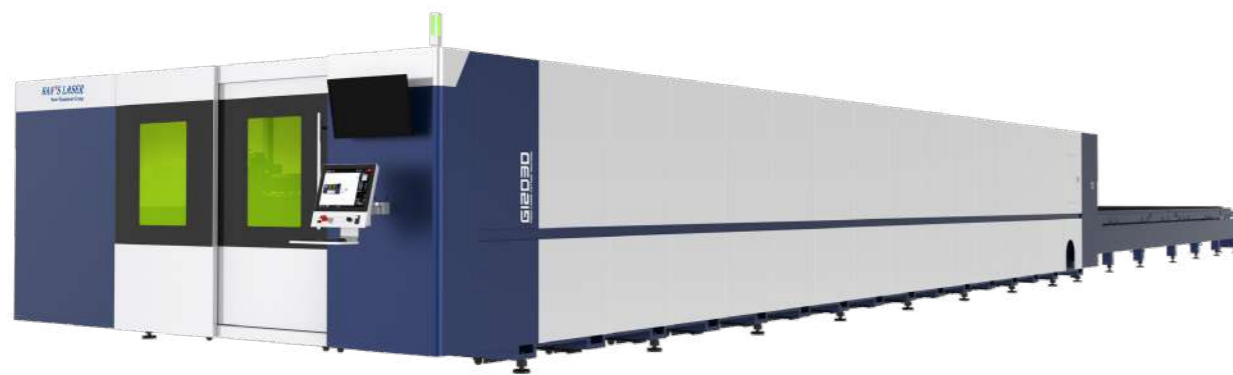

Images only for reference

### Features

- Reliable and strict mechanism design
- Global supplied high-end key functional components and Han's unique algorithms
- Han's innovated multi-axis numerical control system
- The world first bevel cut machine with AB axis real-time monitoring, one-click reset, 3D coordinate self-swift functions.
- Bevel cutting capabilities involves V bevel, Y chamfer, X chamfer, K chamfer and steep bevel cuts.
- Comprehensive solutions for both middle and thick plate cutting

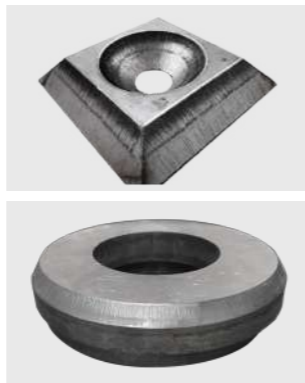

Model	G6025BF	G8025BF
Processing area (L x W)	6000×2500mm	8000×2500mm
Bevel cutting area	5000×1500mm	7000×1500mm
Positioning accuracy (X/Y)	±0.02mm	±0.02mm
Repeatability(X/Y)	140m/min	140m/min
Max. load weight	4800kg	6400kg
Dimension (L x W x H)	16.3×4.06×2.6m	19.2×4.06×2.6m
Laser power	12000W、15000W、20000W、30000W	

1



#### Full-hollow Machine Bed

Rigid and anti-deformation machine bed for 30KW ultra-high power laser cutting

2



#### Brand new user interface

European design UI and UX, Intelligent operation, fluent system reaction

3



#### Z-axis gear and rack system

Patented design, anti-pollution, anti-crashing and fast speed

4



#### Hydraulic workbench

Ensures each metal sheet shift

5

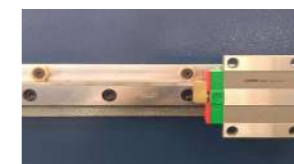

#### Double safety lock guide rail

Prevent accuracy error happen when laser head collides

6



#### Modular workbench for high power laser cutting

Easy to be dismantled and installed

7

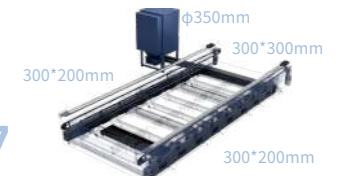

#### Efficient ventilation system

CAE ventilation pathway with large size ventilation channel

8



#### Anti-burning cover for high-power cutting

Easy maintenance and low cost

9



#### High strength tank chain mechanism

Large torque standard with larger bearing weight

	G10025BF	G12025BF
Processing area (L x W)	10000×2500mm	12000×2500mm
Bevel cutting area	9000×1500mm	11000×1500mm
Positioning accuracy (X/Y)	±0.05mm	±0.05mm
Repeatability(X/Y)	120m/min	120m/min
Max. load weight	7850kg	9500kg
Dimension (L x W x H)	25.1×4.23×2.6m	29.2×4.23×2.6m
Laser power	12000W、15000W、20000W、30000W	

\*Only for reference, technical data are subject to technical proposals

# HF PRO Series

Separate Frame Structure - Fiber Laser Cutting Machine

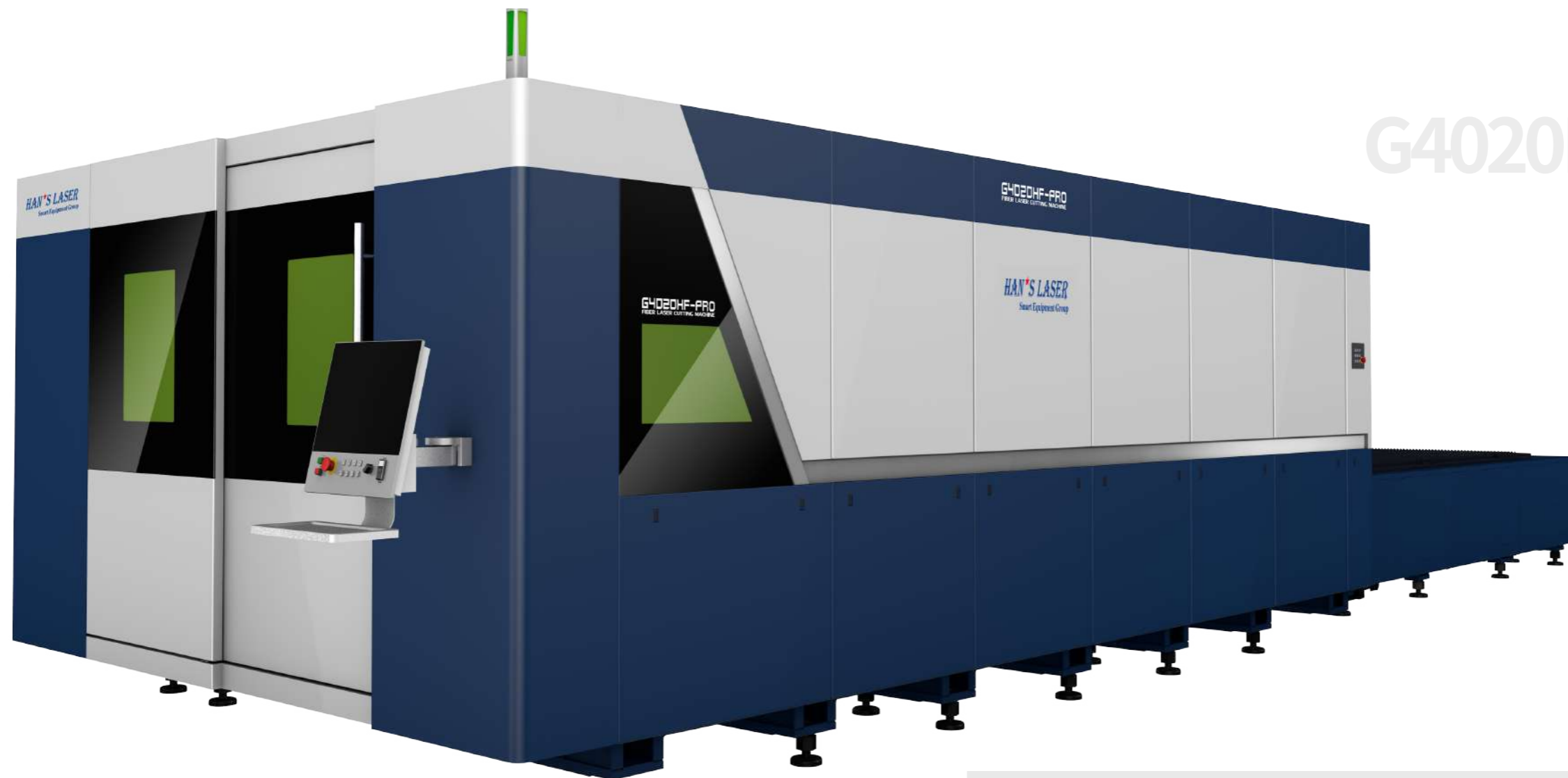

## G4020HF PRO

Images only for reference

## Features

- Reliable and strict mechanism design
- Global supplied high-end key functional components
- Han's unique algorithms
- Han's innovated CNC system
- Processing database for high-power laser applications
- Comprehensive solutions for thin, middle and thick plate cutting



Model	G3015HF PRO	G4020HF PRO	G6025HF PRO
Processing area	3100mm×1570mm	4100mm×2070mm	6150mm×2580mm
Positioning accuracy (X/Y)	±0.03mm/m	±0.03mm/m	±0.03mm/m
Repeatability (X/Y)	±0.02mm	±0.02mm	±0.02mm
Positioning Speed (X/Y)	200m/min	200m/min	160m/min
Positioning Speed (Z)	100m/min	100m/min	100m/min
Acceleration (X/Y)	3G	3G	2.5G
Acceleration (Z)	4G	4G	4G
Max. load weight	900Kg	1600Kg	7000Kg
Dimension (L x W x H)	9.6m×3.05m×2.16m	11.2m×3.47m×2.16m	15.7m×4.06m×2.4m

\*Only for reference, technical data are subject to technical proposals

# F series

Fiber laser cutting machine

## G6025F



Images only for reference

### Features

- With Han's laser cutting technique, the F-series machine is suitable for processing various sheet metal materials, such as carbon steel, stainless steel, brass, and aluminum
- With the F-series machine, materials can be cut flawlessly without burr and slag generation during the cutting process
- With batch processing functions, users do not need to repeat a task with any extra effort, simply click one button to process multiple metal sheets at once
- Worry-free for sheet metal alignment; F series machines detect edges before processing, making your batch process easy with high quality parts

Model	G3015F	G4020F	G6020F
Processing area	3000mm×1500mm	4000mm×2000mm	6000mm×2000mm
Positioning accuracy (X/Y)	±0.03mm/m	±0.03mm/m	±0.03mm/m
Repeatability(X/Y)	±0.02mm	±0.02mm	±0.02mm
Positioning Speed (X/Y)	140m/min	140m/min	140m/min
Acceleration (X/Y)	2.5G	2.2G	2.0G
Max. load weight	1800kg	3100kg	5600kg
Machine weight	6500kg	10000kg	12600kg
Dimension (L x W x H)	9.2m×3.05m×2.2m	10.95m×3.54m×2.1m	15m×3.5m×2.2m

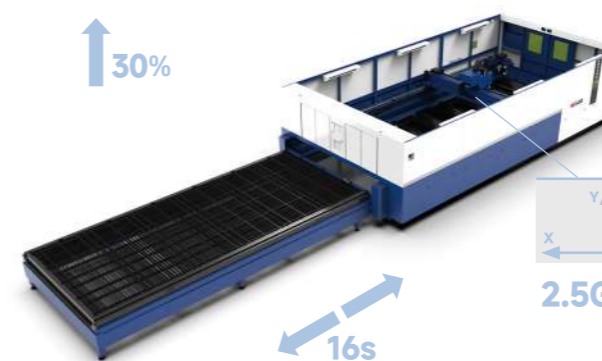
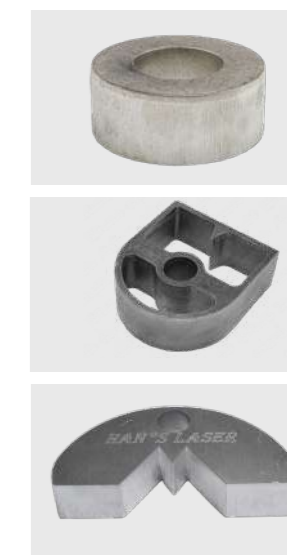

### Features

- Han's SMC EtherCAT bus control system maximally enlarges flexibility of the laser cutting with higher efficiency
- Max. Acceleration can reach up to 2.5G
- Beyond imagination, accurate with thick plate processing and fast deal with thin metal sheets

G6025F	G8025F	G10025F	G12025F
6000mm×2500mm	8000mm×2500mm	10000mm×2500mm	12000mm×2500mm
±0.03mm/m	±0.03mm/m	±0.05mm/m	±0.05mm/m
±0.02mm	±0.02mm	±0.03mm	±0.03mm
140m/min	140m/min	140m/min	140m/min
2.0G	2.0G	2.0G	2.0G
4800kg	9400kg	6000kg	7000kg
16000kg	24000kg	27000kg	32000kg
15m×4.02m×2.32m	19.7m×4.07m×2.2m	24m×4.2m×2.475m	28m×4.2m×2.475m

\*Only for reference, technical data are subject to technical proposals

# PRO series

Fiber laser cutting machine

## G6025PRO



Images only for reference

### Features

- Designed for thin metal processing
- 20-year professional solution for aluminum cutting and slag removal function
- Intelligent anti-collision technology prevents laser head damage from sheet metal impacts
- Remote control availability for urgent troubleshooting, offering technical support to solve machine issues from thousands of miles away



Model	G3015PRO	G4020PRO	G6020PRO	G6025PRO
Processing area	3000mm×1500mm	4000mm×2000mm	6000mm×2000mm	6000mm×2500mm
Positioning accuracy (X/Y)	±0.03mm/m	±0.03mm/m	±0.03mm/m	±0.03mm/m
Repeatability(X/Y)	±0.02mm	±0.02mm	±0.02mm	±0.02mm
Positioning Speed (X/Y)	140m/min	140m/min	140m/min	140m/min
Acceleration (X/Y)	2.0G	2.0G	2.0G	1.8G
Max. load weight	1400kg	2600kg	3800kg	4800kg
Machine weight	6500kg	9700kg	12000kg	13000kg
Dimension (L x W x H)	9.2m×3.05m×2.2m	10.95m×3.54m×2.1m	15.17m×3.465m×2.1m	15m×4.065m×2.32m

\*Only for reference, technical data are subject to technical proposals

# G series

Fiber laser cutting machine

## G3015



Images only for reference

### Features

- Ideal laser cutting for outstanding machine cutting ability
- Bridge-type machine frame with high-torque servo motor that handles 25mm carbon steel metal cutting with ease
- A precise machine with dramatic dynamic motion, effective for both thin and thick sheet metal processing



Model	G3015	G4020	G6020	G6025
Processing area	3000mm×1500mm	4000mm×2000mm	6000mm×2000mm	6000mm×2500mm
Positioning accuracy (X/Y)	±0.05mm/m	±0.05mm/m	±0.05mm/m	±0.05mm/m
Repeatability(X/Y)	±0.03mm	±0.03mm	±0.03mm	±0.03mm
Positioning Speed (X/Y)	120m/min	120m/min	120m/min	120m/min
Acceleration (X/Y)	1.8G	1.8G	1.8G	1.5G
Max. load weight	1000kg	2000kg	3000kg	4800kg
Machine weight	6300kg	9600kg	11800kg	14000kg
Dimension (L x W x H)	9.2m×3.05m×2.1m	10.95m×3.465m×2.1mm	15m×3.46m×2.1m	15m×4.065m×2.1m

\*Only for reference, technical data are subject to technical proposals



# MPS-Precision Series

Small format precision laser cutting machine

## MPS-0806D



Images only for reference

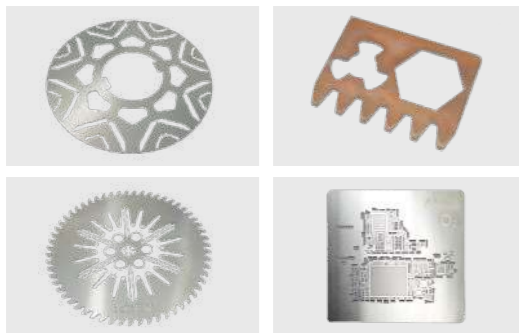

### Product features

- Precision-oriented, high-speed motion control system with mature Han's control technology
- All covered protective mechanical design, available with automation line
- User-friendly maintenance and repair, operation is affordable

Model	MPS-0606LM	MPS-0806D
Processing area	680mm×680mm	800mm×600mm
XY axis location accuracy	±0.002mm/m	±0.03mm/m
XY axis repeat location accuracy	±0.002mm	±0.02mm
Max running speed	48m/min	30m/min
Max load of worktable	5kg	25kg
Power supply	380V/50HZ	380V/50HZ
Machine tool weight	3.0 T	1.0 T
Dimension(L*W*H)	1880×2000×1700mm	2000m×1500m×2000m

\*Only for reference, technical data are subject to technical proposals

# MPS-D/C Series

Fiber Laser Cutting Machine

## MPS-D/C



Images only for reference

### Product features

- Single work table fiber laser cutting machine matches with quick response and precise control unit.
- Compact machine design with less space occupation, simple maintenance and affordable operational consumption.

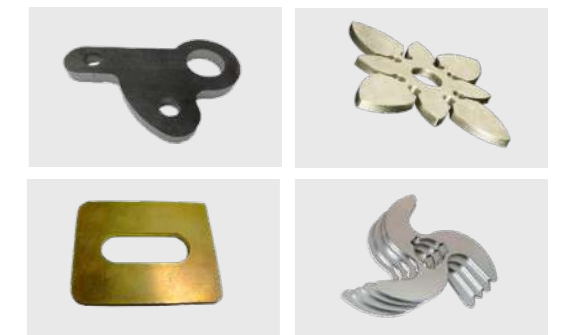

Model	MPS-3015D	MPS-4020D	MPS-6020D	MPS-3015C
Processing Area	3000mm×1500mm	4000mm×2000mm	6000mm×2000mm	3000mm×1500mm
X/Y axis accuracy	±0.05mm/m	±0.05mm/m	±0.05mm/m	±0.05mm/m
X/Y axis repeat positioning ac-curacy	±0.03mm	±0.03mm	±0.03mm	±0.03mm
Max cutting speed	120m/min	100m/min	100m/min	120m/min
Max acceleration	1.2g	1.0g	1.0g	1.2g
Max load weight	700kg	1200kg	1800kg	700kg
Machine weight	About 4.0T	About 7.5T	About 10T	About 5.5T
Dimen-sion(L*W*H)	5000x2600x2000mm	6000×3300×2000mm	8500×3300×2000mm	8500×2250×2200mm

\*Only for reference, technical data are subject to technical proposals

# Giant Series

Giant L Large-format Laser Cutting Machine



Bevel Cutting(optional)

## G24040L



Images only for reference

### Features

- ▶ Laser cutting platform uses 'modular mix-match mode'; the machine is flexible in loading and unloading.
- ▶ Innovative bridge-type frame with 'fix + flexible mode' to reduce deviations during large format processing.
- ▶ Self-adaptive mechanisms for X-axis transmission to guarantee precision for long-distance travel movement.
- ▶ Tracking ventilation system gives an economic and energy-saving experience.
- ▶ Dual bevel cutting head systems with numerical control units reaches flexible 0-±45° angle laser cutting (optional).



Groove sample

Model	G12030L	G18035L	G24040L
Processing area	12000mm×3000mm	18000mm×3500mm	24000mm×4000mm
Repeatability (x-axis / y-axis)	0.06mm/0.05mm	0.09mm/0.06mm	0.12mm/0.06mm
Positioning speed (X/Y)	70m/min	70m/min	70m/min
Dimension (L x W x H)	16.5×4.9m×2.1m	23×5.4m×2.1m	30.5×5.9m×2.1m
Machine weight	6600 t	8200 t	9800 t

Note: Custom available, X axis 12-50m, Y axis 2.5m-5.0m

\*Only for reference, technical data are subject to technical proposals

# Giant Series

Giant T Large-format Laser Cutting Machine

## G16030T



Images only for reference

### Features

- ▶ A large-format machine concentrates on thin and middle-thick sheet processing. The aluminum cross beam features lightweight, good dynamic motion and rigidity that can enhance productivity.
- ▶ Han's internal reverse ventilation doors make 'zone-by-zone ventilation' possible. The control unit automatically opens the corresponding damper for ventilation, effectively removing harmful gases and improving the working environment.
- ▶ The independent laser cutting frame is completely separated from the machine base frame, which effectively eliminates the impact of vibration on the accuracy when loading and unloading parts.



Model	G8025T	G12025T	G16030T
Processing area	8000mm × 2500mm	12000mm × 2500mm	16000mm × 3000mm
Positioning accuracy (X-axis/Y-axis)	±0.05mm/m	±0.05mm/m	±0.05mm/m
Positioning speed (X/Y)	100m/min	100m/min	100m/min
Dimension (L x W x H)	11.2m × 3.8m × 1.8m	15.9m × 3.8m × 1.8m	21.0m × 4.4m × 1.8m
Machine weight	11.0 t	16.0 t	21.0 t

Note: Custom available, X axis 6-16m, Y axis 2.5m-3m

\*Only for reference, technical data are subject to technical proposals

# RDC Series

RDC Coil laser cutting production line



# RDC7018

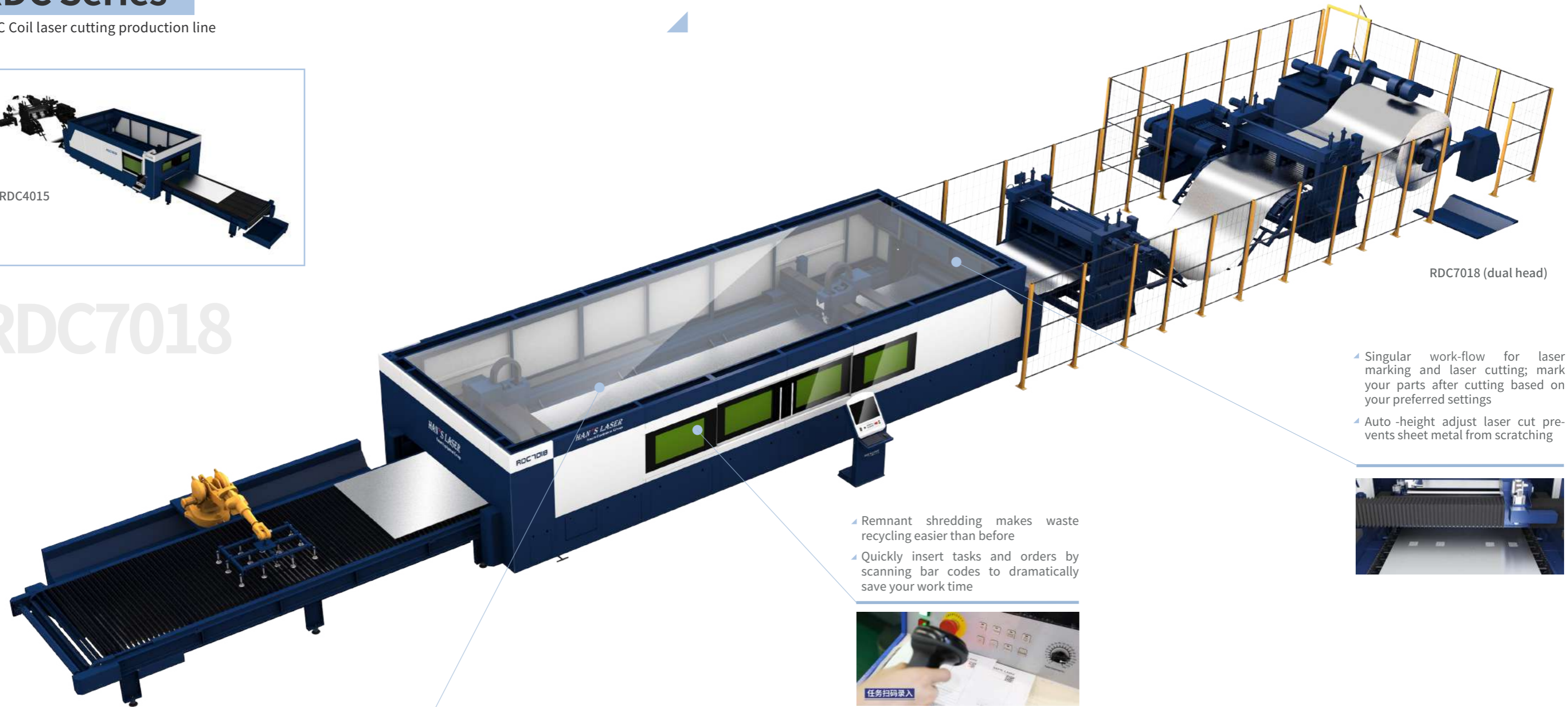

- Single / dual head continuous laser cutting, less production time and more productivity
- Asynchronous dynamic laser cutting with a dual laser cutting head shapes complex part at once. The nesting software calculates appropriate processing route to maximize material utilization.



- Remnant shredding makes waste recycling easier than before
- Quickly insert tasks and orders by scanning bar codes to dramatically save your work time



- Singular work-flow for laser marking and laser cutting; mark your parts after cutting based on your preferred settings
- Auto-height adjust laser cut prevents sheet metal from scratching



Images only for reference

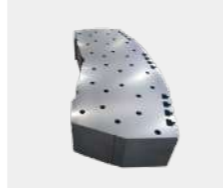
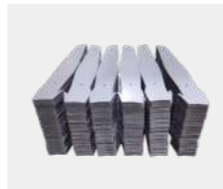

Model	RDC4015	RDC4020	RDC6015	RDC7018(dual head)	RDC8020
Processing area	4000mm×1500mm	4000mm×2000mm	6000mm×1500mm	6500mm×1800mm	8000mm×2000mm
Positioning accuracy (X/Y)	±0.05mm/m	±0.05mm/m	±0.05mm/m	±0.05mm/m	±0.05mm/m
Repeatability(X/Y)	±0.03mm/m	±0.03mm/m	±0.03mm/m	±0.03mm/m	±0.03mm/m
Positioning Speed (X/Y)	140m/min	140m/min	140m/min	169m/min	140m/min
Dimension (L x W x H)	约 20m×5.4m	20m×7m	27m×5.4m	30m×7m	36m×7m

\*Only for reference, technical data are subject to technical proposals

# W Series

3D 5-axis fiber laser cutting machine

## W4525T



Images only for reference

## Product features

- Fixed gantry structure, movable table, has the largest processing space, high dynamic performance
- Three-dimensional head realizes  $n \times 360^\circ$  infinite rotation, high efficiency, from cutting to welding, the swing head can be quickly replaced without adjustment, and one machine can be used for multiple purposes

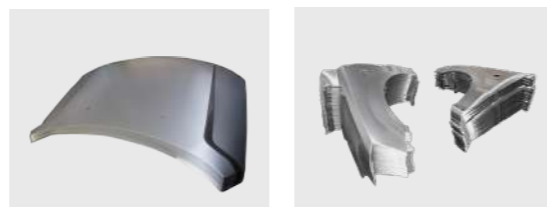

Model	W3525T	W4525T	W5025T
Processing Format (L x w x h)	2950mm x 1950mm x 575mm	3950mm x 1950mm x 575mm	4450mm x 1950mm x 575mm
X/Y/Z axis maximum positioning speed	30m/min	30m/min	25m/min
C/A axis maximum positioning speed	90r/min	90r/min	90r/min
CNC system	Siemens 840Dsl	Siemens 840Dsl	Siemens 840Dsl
Workbench maximum load	>500kg	>500kg	>500kg
Machine weight	5000kg	6000kg	7000kg
Dimensions(L x W x H)	7200mm X 5000mm x 3500mm	9400mm x 5000mm x 3500mm	11000mm x 5000mm x 3500mm

\*Only for reference, technical data are subject to technical proposals

# SL Series

SL Loading Unit

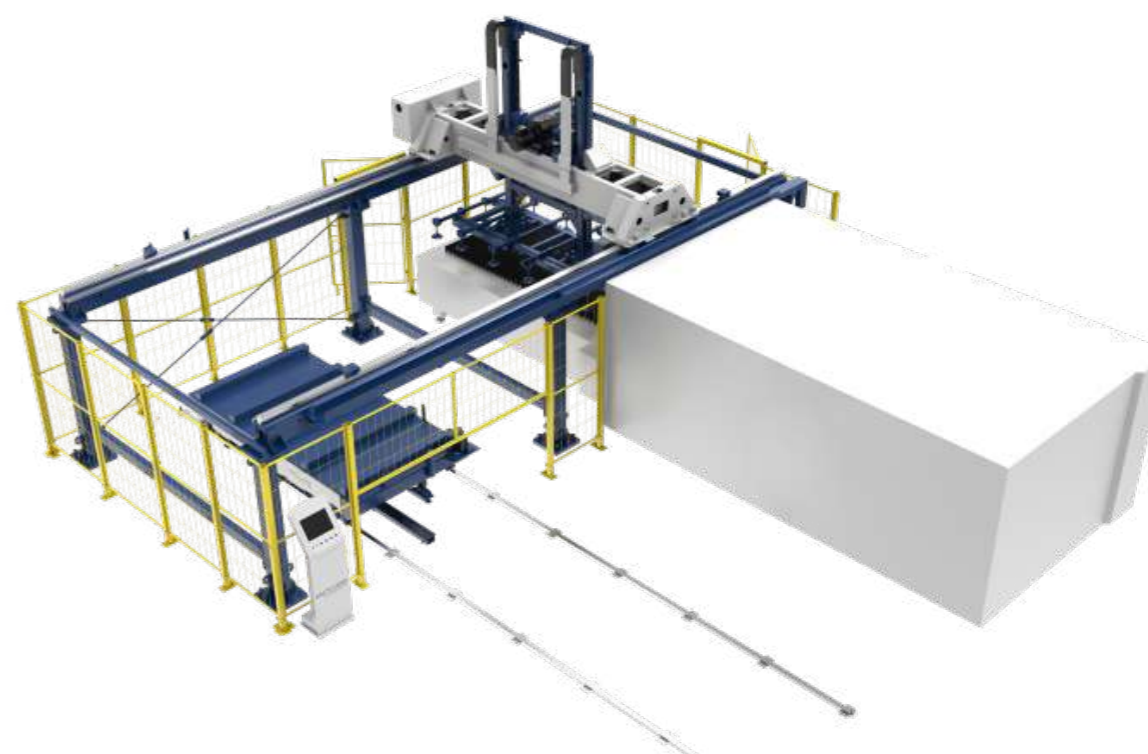

Images only for reference

## Product features

- Fully automatic load sheet metals, the max loading gauge reaches up to 40mm.
- The vacuum suction cup loading device connects with the manufacturing system to execute production tasks and thereby reaching production management.
- A flexible laser automation solution for semi-automated and follow by scheduling covers all steps from order schedule, nesting to raw material shifting, loading and processing.

Model	SL-3015	SL-4020
Speed (loading unit)	50m/min	50m/min
Hoist Speed (loading unit)	8m/min	8m/min
Loading format	3000*1500*16	4000*2000*16
Max. unloading format	3000*1500*16	4000*2000*16
Control System	PLC	PLC
Max. Load weight (sorting car)	4t	4t
Speed (sorting car)	20m/min	20m/min

\*Only for reference, technical data are subject to technical proposals

# SLU Series

Laser automation system

## Loading & unloading device

- ▶ Picking raw metal sheets from shuttle car
- ▶ Final workpieces transferring and blanking

## Sorting and raw material shuttle car

- ▶ Stacking and placing platform for final workpieces and raw materials.
- ▶ Automatically move along the track and transfer the workpieces in time.

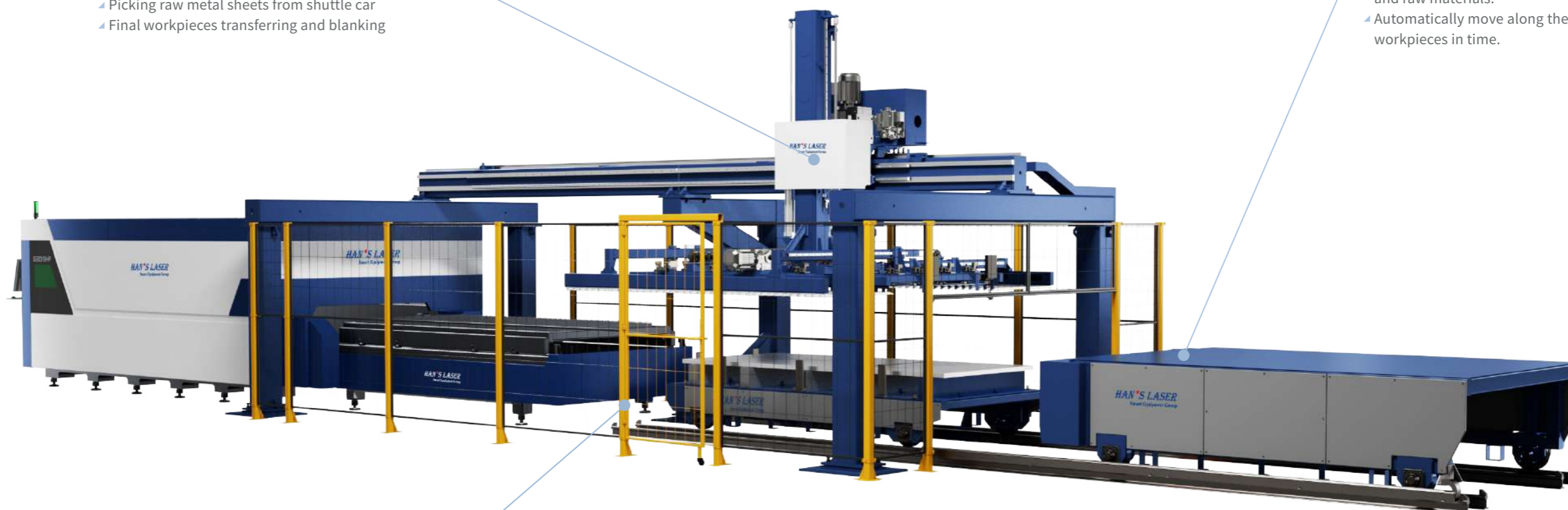

Images only for reference

## Guardrail

- ▶ Safety interlock guardrails prevent staffs from accidentally entering hazardous areas.

## Product features

- ▶ Han's innovated flexible manufacturing system (Takt Time schedule system) schedules orders and tasks.
- ▶ The well-arranged schedule assigns production tasks to laser machine and conduct a continuous loading and unloading, the productivity has increased up to 20% to 50%.
- ▶ The unattended production leads a flexible cycle that maximally reduces human cost.

Model	SLU-3015	SLU-4020
Speed (loading unit)	50m/min	50m/min
Hoist Speed (loading unit)	8m/min	8m/min
Loading format	3000*1500*16	4000*2000*16
Max. unloading format	3000*1500*16	4000*2000*16
Control System	PLC	PLC
Max. Load weight (sorting car)	4t	4t
Speed (sorting car)	20m/min	20m/min

\*Only for reference, technical data are subject to technical proposals

# ALU Series

Laser automation system



Raw material tower

- Automatic metal sheets shifting
- Compact design saves more space.
- Manage various type sheets by orders



Unloading Unit

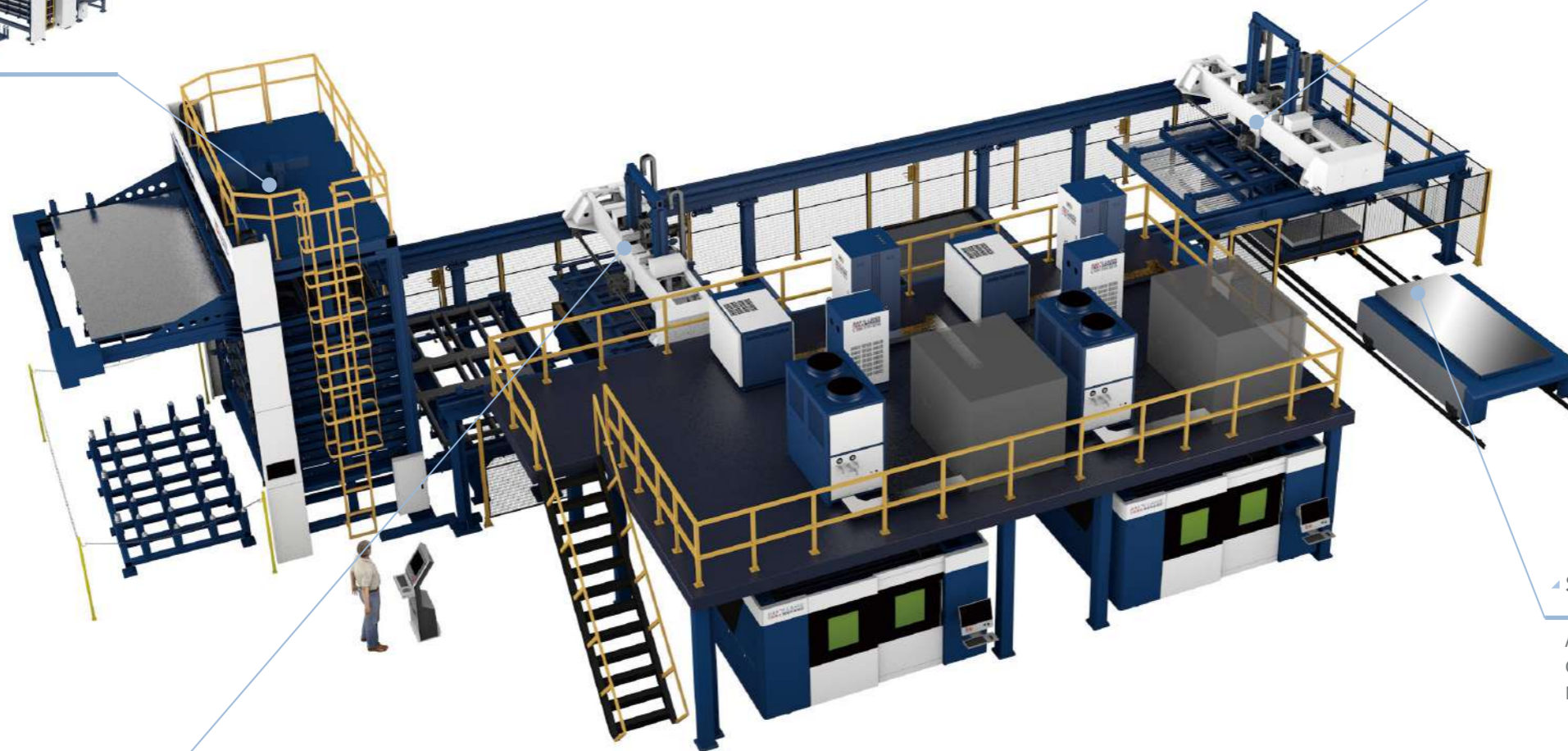

Loading Unit



Sorting Car

- Automatic metal sheets shifting
- Compact design saves more space.
- Manage various type sheets by orders

Images only for reference

## Product features

- Han's innovated flexible manufacturing system (Takt Time schedule system) schedules orders and tasks. The well-arranged schedule assigns production tasks to laser machine and conduct a continuous loading and unloading, the productivity has increased up to 20% to 50%.
- The unattended production leads a flexible cycle that maximally reduces human cost.

Model	G3015/G4020/G602/G6025/G8020/G8025/Custom
Speed (loading unit)	50-60m/min
Hoist Speed (loading unit)	6-12m/min
Max sheet format	8000*2000
Thickness	0-16mm
Control system	PLC+FMS+CNC( Loading&unloading Tark time planning + laser cutting machine
Max. Load weight (sorting car)	4t
Speed (sorting car)	20m/min

\*Only for reference, technical data are subject to technical proposals

## SP series

Sheet and tube laser cutting machine

### SP6020D



Images only for reference

### Features

- Combining flat sheet and tube cutting in one machine, all-in-one solution for both tube and sheet metal fabrication.
- Tube diameter range from 15mm to 230mm, sheet metal format including 4mx2m, 6mx2m and 3mx1.5m.
- SP is the best choice to fit your basic tube and flat metal cutting.



Model	SP3015	SP4020	SP6020
Processing area	3000×1500mm	4000×2000mm	6000×2000mm
Tube processing area (220 chuck)	6200mm×φ15-220mm 6200mm×□15-150mm	6200mm×φ15-220mm 6200mm×□15-150mm	6200mm×φ15-220mm 6200mm×□15-150mm
Tube processing area (330 chuck)		6200mm×φ10-330mm 6200mm×□10-230mm	6200mm×φ10-330mm 6200mm×□10-230mm
Accuracy (X/Y)	±0.05mm/m	±0.05mm/m	±0.05mm/m
Positioning speed (X/Y)	80m/min	80m/min	80m/min
Positioning speed (A axis)	100rpm	100rpm	100rpm
Dimension(L x W x H)	9mX3.6mX2.3m	9mX4.5mX2.5m	9mX4.5mX2.5m

\*Only for reference, technical data are subject to technical proposals

## TP series

Sheet and tube laser cutting machine

### TP6020D



Images only for reference

### Features

- Tube diameters range from 15mm to 230mm; sheet metal formats include 4mx2m, 6mx2m, and 3mx1.5m.
- Combining flat sheet and tube cutting in one machine to provide an all-in-one solution for both tube and sheet metal fabrication. A high-tech laser machine combines cutting-edge laser technology with an advanced control unit.



Model	TP4020	TP6020
Processing area	4000×2000mm	6000×2000mm
Tube processing area (220 chuck)	6200mm×φ15-220mm 6200mm×□15-150mm	6200mm×φ15-220mm 6200mm×□15-150mm
Tube processing area (330 chuck)	6200mm×φ10-330mm 6200mm×□10-230mm	6200mm×φ15-330mm 6200mm×□15-230mm
Accuracy (X/Y)	±0.05mm/m	±0.05mm/m
Positioning speed (X/Y)	80m/min	80m/min
Positioning speed (A axis)	80rpm	80rpm
Tube load weight	200kg	200kg

\*Only for reference, technical data are subject to technical proposals

# PD series

Fiber laser tube cutting machine

## P6018D

Images only for reference

### Popular model

Verified by market

- PD Series fiber laser cutting machine serves as one of the best sales and well-established model, verified by market for a long term

### Han's Mesys System

Verified by market

- Real-time monitoring, automatic notification of equipment maintenance, big-data driven management system, let data works for increasing production

### Features

- Fully automatic tube processing workflow with smart factory management software, adaptable enough to take on any profile
- Patented technique, mechanical chuck, one-click clamping, and auto-centering makes the PD series machine flexible with thin-walled tubes as well as with heavy profile processing tubes as well as with heavy profile processing
- Tube diameter ranges from round and square tubes up to 260mm

Model	P6010D	P6018D	P8018D
Processing area	6200mm × φ20-110mm 6200mm × □ 20-110mm	6200mm × φ20-180mm 6200mm × □ 20-180mm	6200mm × φ20-260mm 6200mm × □ 20-260mm
Unload length	0-2000mm	0-4000mm	4000-8200mm
Positioning speed (x/y)	120m/min	120m/min	100m/min
Max.positioning speed (x/y)	150rpm	120rpm	120rpm
Machine dimension (L x W x H)	11m × 4.5m × 2.8m	13.2m × 5.2m × 3m	15m × 4.5m × 2.8m

\*Only for reference, technical data are subject to technical proposals

### Versatility

Flexible to any tube profiles

- Optional laser-cut functions for channel steel, H shape-tubes, bar section and any other special shaped tubes

### Outstanding effectiveness

Experience-based machine

- The X, Y and Z linear axes and the A and B rotary axes are all imported from Germany with high torque servo motors. High precision, high rotation, high torque and large inertia ensure high speed and acceleration of the whole machine

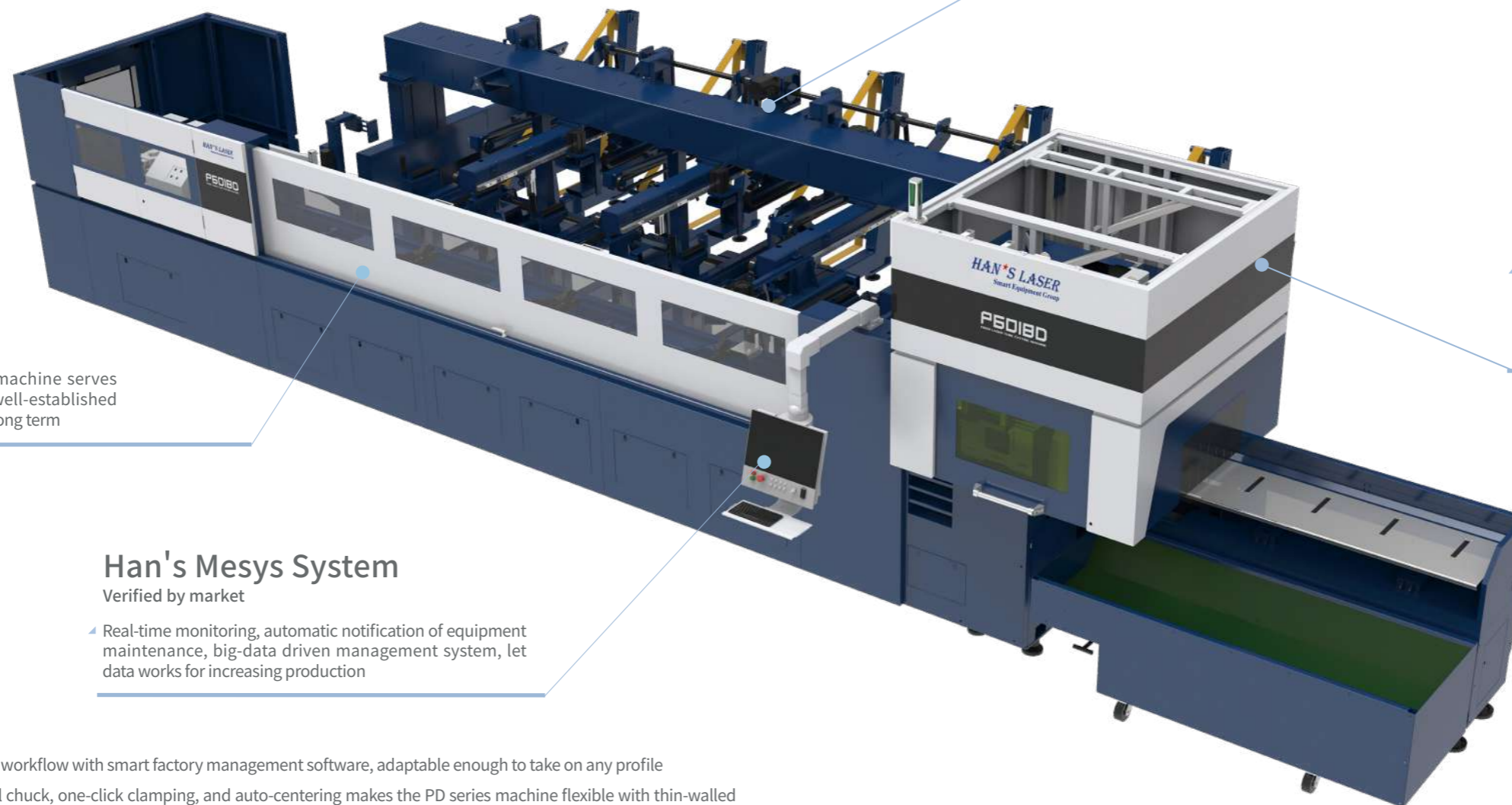

Model	P8026D	P10026D	P12026D
Processing area	8050mm × φ20-260mm 8050mm × □ 20-260mm	10050mm × φ20-260mm 10050mm × □ 20-260mm	12500mm × φ20-260mm 12500mm × □ 20-260mm
Unload length	0-4000mm	0-4000mm	0-4000mm
Positioning speed (x/y)	100m/min	100m/min	100m/min
Max.positioning speed (x/y)	100rpm	100rpm	100rpm
Machine dimension (L x W x H)	16m × 6m × 3m	19m × 6m × 3m	21m × 6m × 3m

\*Only for reference, technical data are subject to technical proposals



# PDi series

Fiber laser tube cutting machine

## P6018Di

Images only for reference

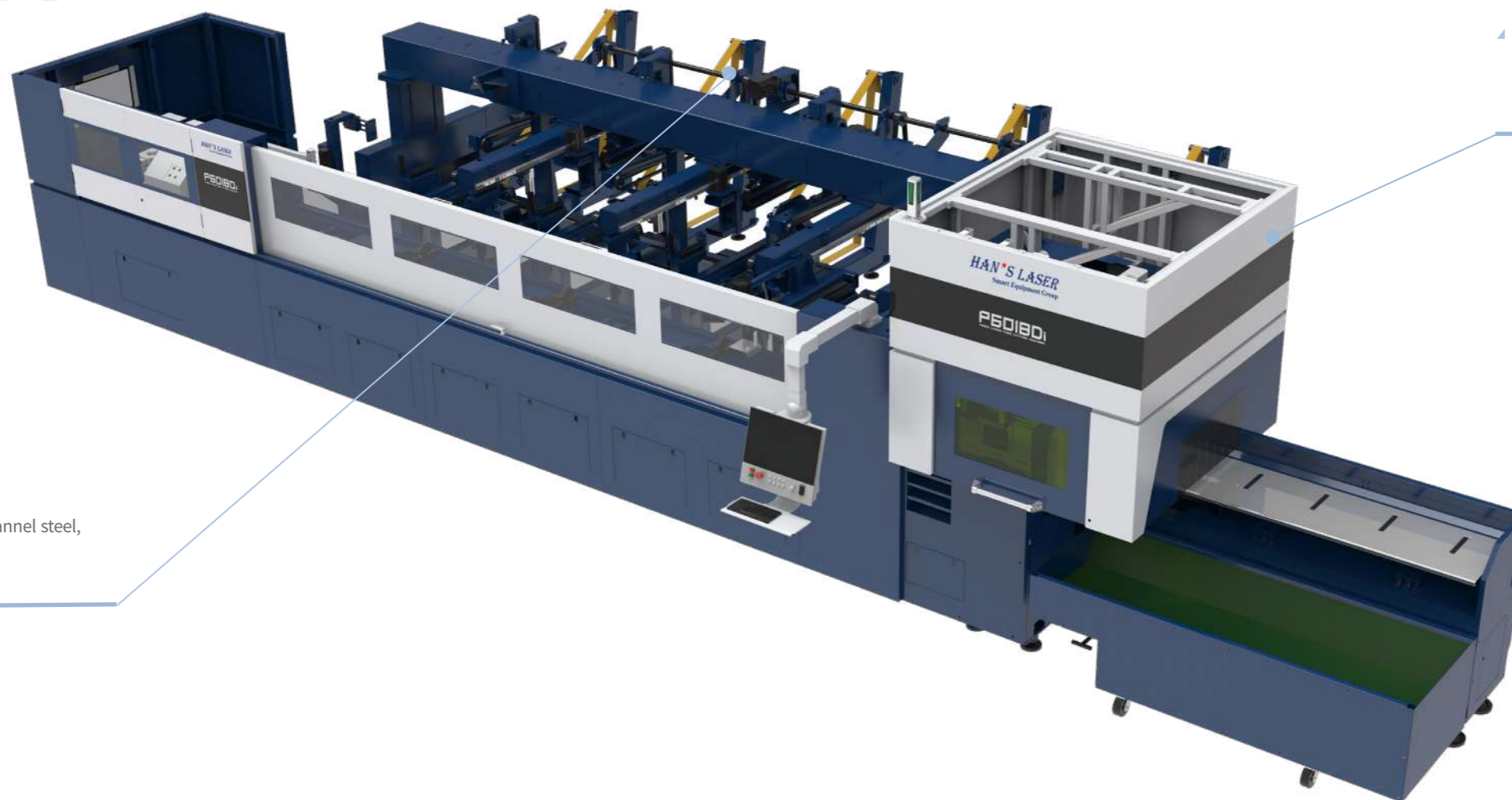

### Versatility

Flexible to any tube profiles

- Optional laser-cut functions for channel steel, H-beam and steel profiles.

### Outstanding effectiveness

Experience-based machine

- The X, Y and Z linear axes and the A and B rotary axes equip with high torque servo motors. High precision, high rotation, high torque and large inertia ensure high speed and acceleration of the whole machine

### Features

- Fully automatic tube processing workflow with smart factory management software, adaptable enough to take on any profile.
- Patented technique, mechanical chuck, one-click clamping, and auto-centering makes the PDi series machine flexible with thin-walled tube as well as with heavy profile processing.



Model	P6010Di	P6018Di
Processing area	6200mm×φ20-110mm 6200mm×□20-110mm	6200mm×φ20-180mm 6200mm×□20-180mm
Load length	4000-6200mm	4000-6200mm
Max.load weight	3000kg	3000kg
Unload length	0-2000mm	0-4000mm
Machine weight	12000Kg	15000Kg
Single tube weight	150kg ≤ 25Kg	200kg ≤ 25Kg
Machine dimension (Lx W x H)	11m × 4.5m × 2.8m	13.2m × 5.2m × 3m

\*Only for reference, technical data are subject to technical proposals

# TD series

Fiber Laser Tube Cutting Machine



## T6022D

Images only for reference

### Product features

- A professional pipe cutting machine designed and produced to assist SME manufacturers with industrial innovation. Good proximity makes cutting and feeding easier.



Model	T6016D	T6022D	T10025D
Processing area (L x diameter)	6200mm × φ20-160mm 6200mm × □ 20-120mm	6200mm × φ15-220mm 6200mm × □ 15-150mm	10200mm × φ20-250mm 10200mm × □ 20-200mm
Cutting speed	100rpm	100rpm	100rpm
Max.weight of single tube	100kg	150kg	200kg
Unload tube length	0-2000mm	0-2000mm	0-2000mm
Positioning speed	100m/min	100m/min	100m/min

\*Only for reference, technical data are subject to technical proposals

### Modular design /flexible combination

Han's tube laser series uses mix and match modular load and unload structure. This modular combination brings users much more flexibility to fit their own needs.

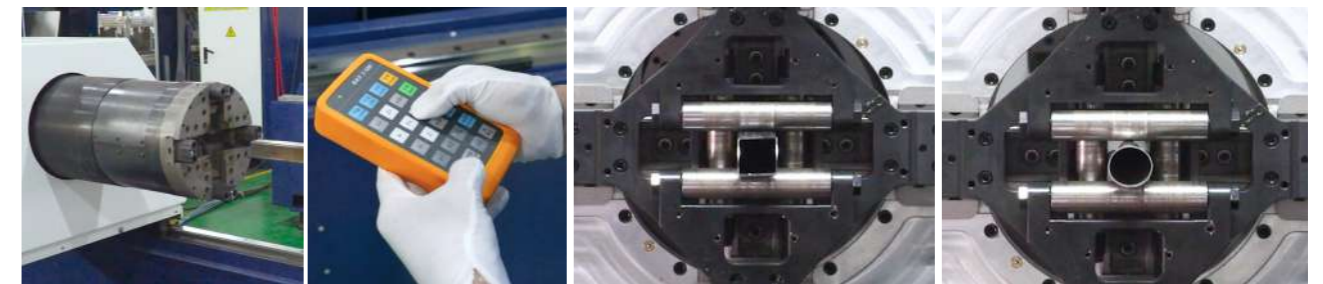
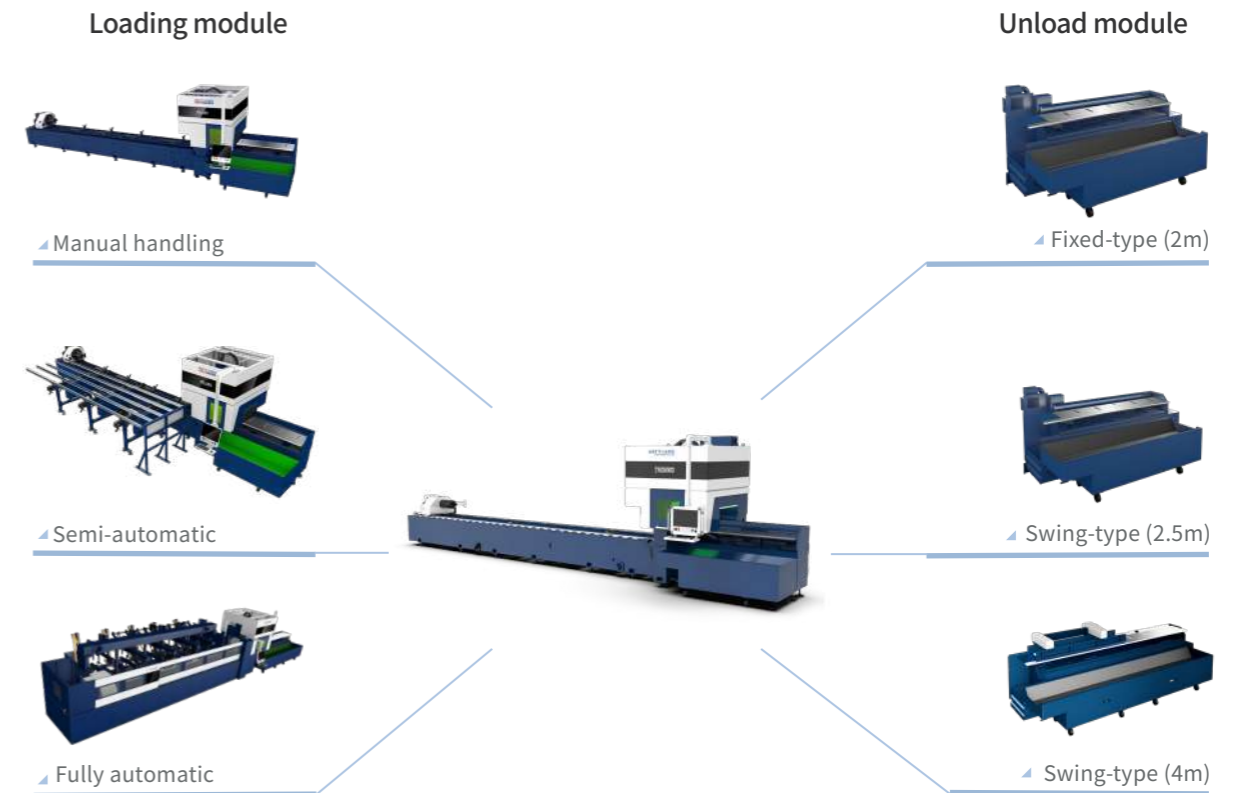

Remote control device

Compatible with square, round, oval, channel steel, profiles and etc.

Model	T10035D	T12033D	T12035D
Processing area (L x diameter)	10050mm × φ20-260mm 10050mm × □ 20-260mm	12000mm × φ15-330mm 12000mm × □ 15-230mm	12500mm × φ20-350mm 12500mm × □ 20-260mm
Cutting speed	80rpm	90rpm	100rpm
Max.weight of single tube	300kg	500kg	500kg
Unload tube length	0-4000mm	0-2000mm	0-4000mm
Positioning speed	80m/min	100m/min	100m/min

\*Only for reference, technical data are subject to technical proposals



HANS95 20220512

## **Han's Laser Smart Equipment Group Co., Ltd.**

Add: Han's Technology Center, No.9988 Shennan Road,  
Nanshan District, Shenzhen, China

Add: 128 Chongqing Road, Han's Laser Global Production  
Base, Baoan District, Shenzhen, China

[www.hanslaser.net](http://www.hanslaser.net)

E-mail: [info@hanslaser.com](mailto:info@hanslaser.com)

All technical data and models are subject to change without notice.